

wipcool[®]
FEELING FOR MORE

TANK CONDENSATE PUMP
P180/380/580
— OPERATION MANUAL —

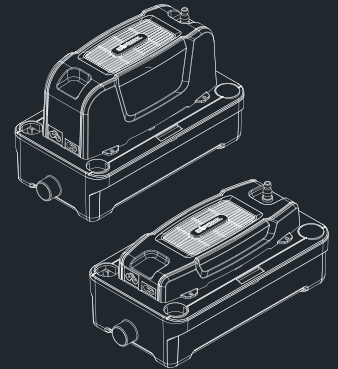

wipcool[®]
FEELING FOR MORE

www.wipcool.com

Reliable Operation
Simple Maintenance



1. Product Indication Chart

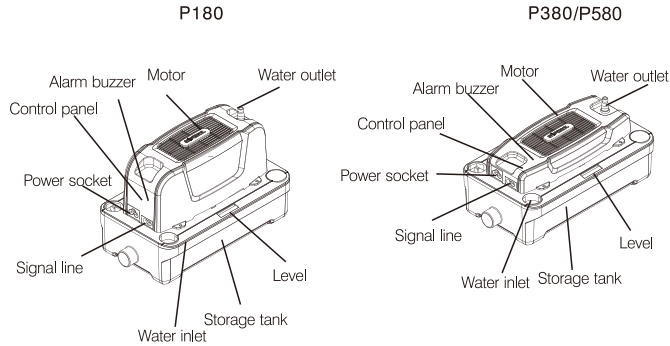

2. Dimension

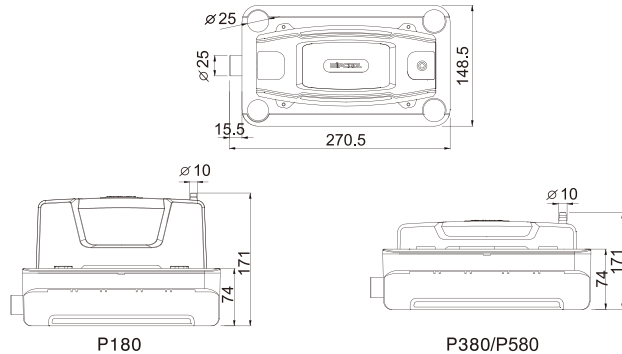

7. Troubleshooting

Problem	Cause	Action
Pump runs all the time	1. Installation is not horizontal	Adjust the tank make it level
	2. There is sludge inside tank	Clean the inside of tank and probe surface
Pump makes loud noise	1. The water is siphoning back in the pump	Check whether the outlet pipe is lower than pump thus result in siphoning, please raise the condensate pump position
Pump can't start working	1. Installation is not horizontal	1. Adjust the tank, check water level
	2. The power can't reach pump	2. Check power supply
	3. The voltage isn't correct	3. Check the voltage

Note: Proper use and maintenance can improve the life of pump. We suggest to check and clean the condensate pump before seasons changing or next year using.

6.4 Connect power supply and signal line;

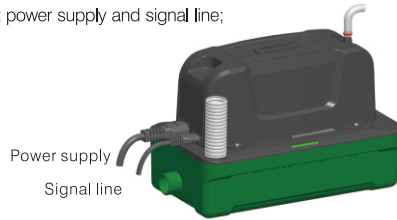

Power supply
Signal line

- 6.5 After the system is properly connected, ensure that the pump is powered on, run the air conditioner and observe whether the pump is working normally. If the pump does not work properly, please contact a professional for repair.
- 6.6 The pump is internally provided with an alarm buzzer, when fails to drain out water and water rises to a certain height, the alarm buzzer will emit a "dripping ... dripping" sound.
- 6.7 When the water outlet nozzle is blocked, it can be manually disassembled and assembled after the matter is cleaned. The detailed steps are shown in the following figure.

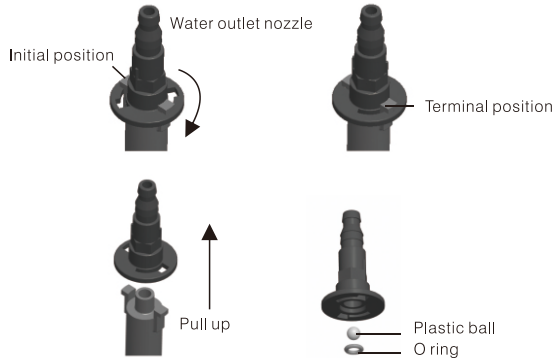

3. Technical Data

Model	P180	P380	P580
Voltage	230V~/50-60Hz 115V~/60Hz	100V-230V~/50-60Hz	230V~/50-60Hz 115V~/50-60Hz
Discharge head(max.)	4.5m(15ft)	6.8m(22ft)	12m(40ft)
Flow rate(max.)	180L/h(48GPH)	380L/h(100GPH)	580L/h(153ft)
Tank capacity	1.8L		
Power consumption	60W	20W	90W
Sound level at 1m	48dB(A)	28dB(A)	60dB(A)
Ambient temp.	0°C~50°C		

4. Flow Rate Chart

Meters head (m)

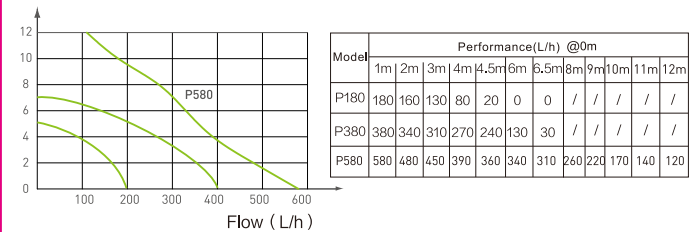

5. Safety Instructions



1. Place the tank horizontal when installing, do not tilt the pump. Check whether the level drop is centered; if there is tilt, adjust the water level before using it.



2. Do not place electrical appliances or valuables under the condensate pump to avoid loss caused by power failure or water leakage.



3. Non - professional personnel should not install it to avoid danger.



4. The condensate pump is not waterproof. Do not place it in the open air, outdoors or in a place prone to flooding.



5. The condensate pump power supply needs to be independent to maintain permanent power supply. For details of connecting with air conditioning system, please refer to the wiring diagram.



6. It is prohibited that the water inflow is bigger than our stated flow rate, which will easily cause the motor to work continuously and fail. Instant big water inflow will also cause the condensate pump fail to discharge water in time, leading to water leakage.



7. The condensate pump has a built-in buzzer. When the buzzer sounds all the time, please turn off the air conditioner and ask a professional to repair it.

6. Installation Procedure

6.1 Cut off the power;

6.2 Install the hanging plate (in the accessory bag) horizontally at a suitable position, and then hang up the condensate pump; (When fix on the wall)

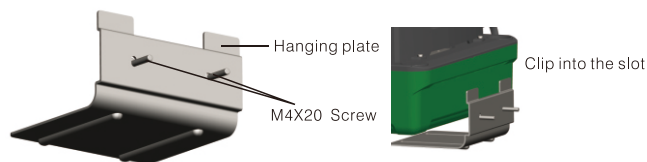

6.3 Insert the pipe of refrigeration system into the water inlet of pump, and connect the pipe with 6x9 plastic pipe and fix it with tie (tie is in the accessory bag);

